

MOPPING EQUIPMENT

Item #	Description	Pack	Cs.Wt.
218	Divided Pail 18 qt. 18" x 13" x 11" Casters Available #P242-06C	5	20.2
242-06	Combo 24 qt. Little Giant™ w/ 2" non-marking casters & Squeeze Wringer (12 - 20 oz.)	1	9.0
353-01	Combo 35 qt. w/ 3" non-marking casters & Squeeze Wringer (12 - 32 oz.)	1	17.8
353-04	Combo 35 qt. w/ 3" non-marking casters & Downpress Wringer (12 - 32 oz.)	1	16.5
361	Squeeze Wringer (12 - 32 oz.)	2	17.7
364	Down Press Wringer (12 - 32 oz.)	2	12.8
7070-0	Bucket 6 gal. Capacity (19¼" x 9½" x 9½")	10	30.8
7070-1	Casters 4 wheels / set	1 set of 4	.7

Little Giant™

- Removable divider separates dirty water from clean solution and functions as a splash guard to keep water splash off floor.



242-06

Removable bucket divider 242-06



353-01

- Elevated rear bucket ledge for wringer leverage.
- Molded-in graduations.
- Rust resistant hardware.
- Smooth and easy-to-clean.
- Bold bilingual CAUTION message.
- Shown with #361 wringer.



361



7070-0

NEW

- Divided pail 18 qt. separates solution.
- Chrome handle.
- Easy pour spout.
- Fits up to 13" sponge mop.
- Casters available.



218



353-04

- Bucket & Wringer interchangeable with most manufacturer's equipment.
- 3" ball bearing, non-marking casters.
- Stainless steel return spring.
- Nylon reinforced gears.
- Bold bilingual CAUTION message.
- Shown with #364 wringer.



364



Mop Rest

60" Overall

Stainless Steel



7070-0

7070-1

Aluminum Fork

8114

8113

NEW

GREEN GIANT PVA SPONGE MOP SYSTEM

Item #	Description	Pack	Cs.Wt.
7070-0	Bucket 6 gal. H.D. polyethylene without casters	10	30.8
7070-1	Casters, set of 4 for 7070-0 bucket	1 Set	.7
8113	Sponge Mop with adjustable handle, 13" wide sponge	4	8.2
8114	13" Replacement Sponge Mop Head	2	1.6

- 100% PVA does not promote bacteria & is static free.
- Sponge packed moist, ready to work when you are.
- Chemically resistant to acids, bases & organic solutions
- Attracts lint, pet hair and other particulates like a magnet - holds until rinsed out.
- Lifts and Absorbs 12 times it's dry weight. Holds 14 oz. of liquid without dripping.
- Applies solution evenly on floors, and without dripping on walls, or ceilings.
- Adjustable stainless steel handle minimizes arm and back exertion.
- Extraordinary 60" overall reach when handle is fully extended.

Ergonomic handle.



Double wringer rollers, for a clean, drip free mop.



Jumbo 13" PVA Sponge, with 11 cleaning ridges.



SAFETY CONES

Item #	Description	Height	Pack	Cs.Wt.
129	Pop-Sign™ "CAUTION" sign only	20"	6	4.7
130	Pop-Sign™ with holster	20"	6	7.5
133	Blinking Light for Pop-Sign™	5"	2	.4
145	Pop-Sign™ large "CAUTION" sign only	32"	6	6.0
146	Pop-Sign™ large with holster	33"	6	12.0

Pop-Sign™

- 4 Sided warning. (Tri-lingual)
- Footprint 19" x 19"
- Velcro storage strap.
- Collapse to store or holster mounts on cleaning cart, work van or strategically on walls for potential hazards.
- Durable materials with-stand abuse.
- Complies with ANSI



133

Blinking LED Light

- Light flashes 1500 times in 24 hour period.
- Night visibility to 850'.
- Runs on 1 "D" cell battery. (Not included)



Umbrella style Velcro strap allows for easy handling.



129



130



146



145

Holster mounts to any flat surface for convenient storage

SIGNS & BARRIERS

Item #	Description	Height	Pack	Cs.Wt.
120	Mobile Barrier 40" high, expands to 13'	40"H	1	40.0
124	Easel Sign "CAUTION WET FLOOR"; bilingual	25"H	6 ♦	11.2
124-1	Easel Sign "NO ENTRY"; Bilingual	25"H	6 ♦	11.2
140	Barrier Sign "CLOSED FOR MAINTENANCE", bilingual.	18" x 14"	6	9.4
8511	Infosigns Notice Holder Minimum Order 5 ♦	8½" x 11"	5/50	1.9

Tightening Nut

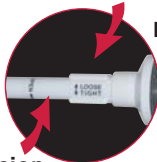

Rubber tips to grip and protect contact points.

Torsion Lock



Blocks doorway or halls from 30" to 53" wide for cleaning or maintenance



140



124



124-1



INFOSIGNS **NEW**

- Clear acrylic plastic.
- Peel and stick (Remove without damage) doors, walls or glass.
- Accommodates standard 8½" x 11" page Change message quickly.
- Apply to entrances, waiting areas, break rooms, rest rooms and checkout areas.

Display your message like a professional. No more laminating, pins, hooks or tape.

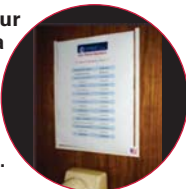

8511

Peel & Stick



Use Anywhere



Uses Standard 8½" x 11" Paper

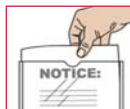

MOBILE BARRIER **NEW**

- For indoor use.
- Flexible - straight or curved.
- 16 panels, expands to 13'.
- Two 5" non-marking wheels.
- Four bungees straps to secure when closed.
- Compact footprint when closed 2' x 13".
- Complies with ANSI color and graphics.
- Shipped assembled.



Collapse and roll-away for easy storage.



120

Bungees holds barrier in compact 2' x 13" footprint for storage.



EXPANDS 13'

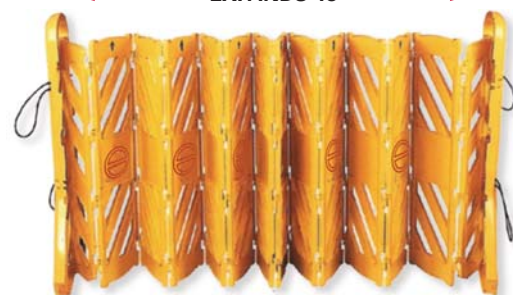

MICROFIBER - Sustainable cleaning, without chemicals

Microfiber offers high efficiency and lint free cleaning. Functions electrostatically with minute split fibers composed of polyimide and polyester (over 180,000 fiber terminals per square inch). These lift stains and scrape particles into the cloth, instead of scratching the surface being cleaned.

Flat, Flexible, Extendable & Washable

FLEX DUSTER SYSTEM NEW

Item #	Description	Color	Pack	Cs.Wt.
1617	Flex Duster System	Blue/Aluminum	10	10.2
	(1) Flex Duster Wand 21"			
	(1) Telepole Pole 2 Section 23"- 37" (2) Microfiber Sleeves 3" x 17"	Aluminum		
1618	Replacement Microfiber Sleeves	Blue	◆ 2/12	4.8

- Launderable microfiber sleeve.
- Flexible wand has memory.

Telepole ➤ PLUS

maximize reach of wand with any ACME thread handle.



Point of sale package.



1617 System

MICROFIBER CLOTHS

Microfiber Cloths in Smart colors.

A All purpose-dusting and cleaning.

B Glass and polishing.

C Rest room.

Item #	Size	Spec.	Usage	Pack	Cs.Wt.
1608-YW	8" x 12"	Textured	A	24◆	1.4
1612-LG-S	12" x 12"	Suede	B	12◆	1.0
1612-BL	12" x 12"	Textured	A	12◆	1.3
1612-LG-T	12" x 12"	Textured	A	12◆	1.3
1616-GN	16" x 16"	Textured	A	10◆	1.7
1616-RD	16" x 16"	Textured	C	10◆	1.7
1616-YW	16" x 16"	Textured	A	10◆	1.7



MICRO-MOP FLAT MICROFIBER PADS

Dry MicroMop White, Full Fringe

(4" backing, 4" to 5" fringe)

High-pile and looped 2" fringe construction grabs and holds larger dust particles and debris. Provides twice the surface area of non-fringe pads.

Item #	Description	(W x L)	Pack	Cs.Wt.
1644-18	Fringed Duster	4"- 8" x 24"	6◆	3.7
1644-24	Fringed Duster	4"- 9" x 30"	6◆	4.5
1644-36	Fringed Duster	4"- 9" x 41"	6◆	6.0

Wet or Dry MicroMop Blue

Low abrasive for general use

1650-18	Maintainer MicroMop	5¼" x 19"	6◆	2.3
1650-24	Maintainer MicroMop	5¼" x 25"	6◆	2.5
1650-36	Maintainer MicroMop	5¼" x 37"	6◆	3.2

Wet MicroMop Yellow Blue Bumblebee

Removes stubborn spots and dried-on food. Vertical strips reach into tile grout line.

1665-18	Scrubber MicroMop	5¼" x 18½"	6◆	3.8
1665-24	Scrubber MicroMop	5¼" x 24½"	6◆	4.6

1644 Series



1650 Series



1665 Series

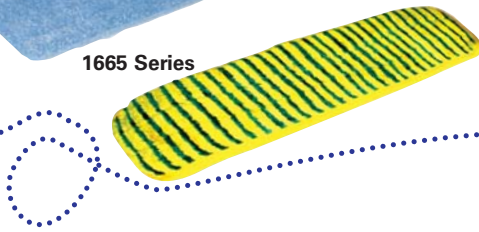

- Cuts cleaning time in half on walls and floors.
- Water, chemical reductions to 90%.
- Withstands 300 machine laundry cycles.
- Dries quickly to reduce slip & falls.
- Removes more bacteria than conventional mops.
- Back injuries reduced; no lifting of bucket and wringer.

MICRO MOP HOLDER - ALUMINUM

Item #	Description	Pack	Cs.Wt.
160-18	MicroMop Holder w/ Velcro 18"	6/36	3.2
160-24	MicroMop Holder w/ Velcro 24"	6/36	4.4
160-36	MicroMop Holder w/ Velcro 36"	6/36	5.6
5055	Handle Telescopic twist-lock aluminum 39" - 71" adjustable length 2 section	12	2.5
5056	Handle, rigid aluminum 7/8" x 56" (Details page 6)	10◆	8.0



160 Series
Bottom detail



160 Series



5055

360° swivel head

Mop is held securely in place by 2 Velcro strips that run the length of the frame.



GRID FLAT MICRO MOP SYSTEMS

Item #	Description	Pack	Cs.Wt.
155	Snapper Connector for Flat Mop Grid	4	1.5
151-0	Velcro Tabs (Only)	12 ♦	.4
151-18	MicroMop Grid Frame 5" x 18" w/ 6 Velcro Tabs	4	4.3
151-24	MicroMop Grid Frame 5" x 24" w/ 6 Velcro Tabs	4	5.3
151-36	MicroMop Grid Frame 5" x 36" w/ 8 Velcro Tabs	4	6.8



155

Key Features Snapper Connector:

- Structural plastic construction.
- 180° swivel or locked for straight pattern.
- Fits 15/16" to 1 1/16" dia. handle. Recommended AIM™ handles 5056 and 5058.

151 Series has strategically located Velcro tabs to secure pad to base.

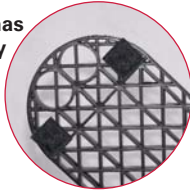

- Structural plastic.
- Quiet.
- Grid design keeps mop flat on the floor.
- Institutional application, where metal is prohibited.

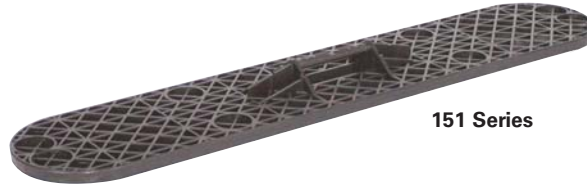

151 Series

180° swivel or locked for straight pattern.

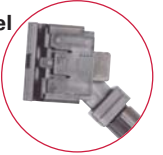

DOUBLE-WIDE FLAT MICRO MOP SYSTEM

Item #	Description	Pack	Cs.Wt.
151-06	Double-Wide Bridge Frame (only) 72" swath	2	4.2
151-72	72" Double-Wide Assembly (Complete) Includes (2) 151-36" Grids with Velcro tabs.	1	5.8

- Designed exclusively for the Dust-Grids.
- Structural plastic construction.
- Fits any 15/16" to 1" diameter handle. Recommended AIM™ handle is 5058.

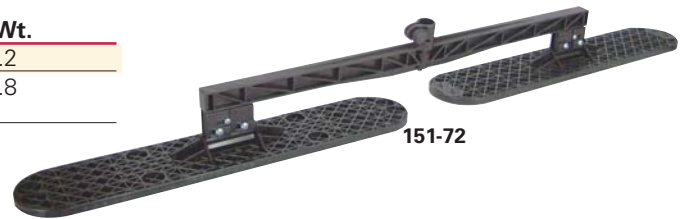

151-72

DOUBLE-WIDE SYSTEM FOR TRADITIONAL DUST MOPS

Item #	Description	Pack	Cs.Wt.
154-04	Double-Wide Bridge Frame (only) 48" swath	2	3.3
154-06	Double-Wide Bridge Frame (only) 72" swath	2	4.4
154-48	Double-Wide Assembly 48" includes 2 #150-24 grids	1	4.3
154-72	Double-Wide Assembly 72" includes 2 #150-36 grids	1	5.7

ACME or compression lock secures handle



154-04

Slide Latch secures frames to bridge



154-48

GRID FRAME SYSTEM FOR TRADITIONAL DUST MOPS

Item #	Description	Pack	Cs.Wt.
155	Snapper Connector for Dust Grid	4	1.5
150-18	Dust Mop Grid Frame 5" x 18"	4	4.0
150-24	Dust Mop Grid Frame 5" x 24"	4	5.3
150-36	Dust Mop Grid Frame 5" x 36"	4	7.0

- Structural plastic will not rust or corrode.
- Maximizes dusting ability of mop strands.
- Ribbing acts as beater when shaking out mop.
- Most quiet mopping available.
- Requires 155 Snapper to attach handle to frame.
- Ribbed design keeps mop flat to the floor surface.
- Institutional application - All plastic design reduces potential for making weapons. Recommended AIM™ handles are 5056 or 5058. (See page 6)



150 Series

155 Snapper shown with Dust Grid Frame

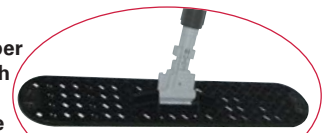

HANDLES, MOP HANDLES & SPONGE MOP

Item #	Description	Ø x L	Pack	Cs.Wt.
5055	Handle Telescopic twist-lock aluminum 39" - 71" adjustable length 2 section (See page 4)	7/8" x 71"	4	2.5
5056	Handle, aluminum w/ ABS plastic grip (Fits 155, 160 Series, 7085 & 7086)	7/8" x 56"	10 ♦	8.0
5058	Handle, aluminum w/ ABS plastic grip (Fits 150, 151, 154, 155, 5110)	1" x 59"	10	9.0
8113	13" PVA Sponge Mop with stainless steel adjustable handle	1" x 60"	4 ♦	8.2
8114	13" PVA Replacement Sponge Mop Head for #8113		2 ♦	1.6
8125	Mop Stick, Gator-Lock plastic coated steel handle w/ hanger	1" x 60"	12 ♦	14.0
8130	Mop Stick, Jaw Style plastic coated steel handle w/ hanger. Fits all wide band mops.	1" x 60"	12 ♦	14.4



- Holds 14 oz. without dripping.
 - Walls or floors.
 - 4 rollers.
 - Moist pack.
- (Details page 2)

SCRAPERS & RAZORS

Item #	Description	Pack	Cs.Wt.
7040	Scraper 8" overall with 4" Blade - Fits telepole cone	10 ♦	3.2
7041	Scraper 13" overall with 4" blade	10 ♦	4.8
7042	Scraper 51" overall with 4" blade	10 ♦	6.0
7043-2	4" Replacement scraper blades 10/pack	10 x 12 ♦	1.0
7043-3	4" Replacement scraper blades 10/pack	10 x 30 ♦	2.4
7048-0	Pocket scraper for single edge razors 1 1/2" width	50	6.3
7049-1	Single edge razor for 7048-0 Minimum order 100 ♦	100/1000	6.0

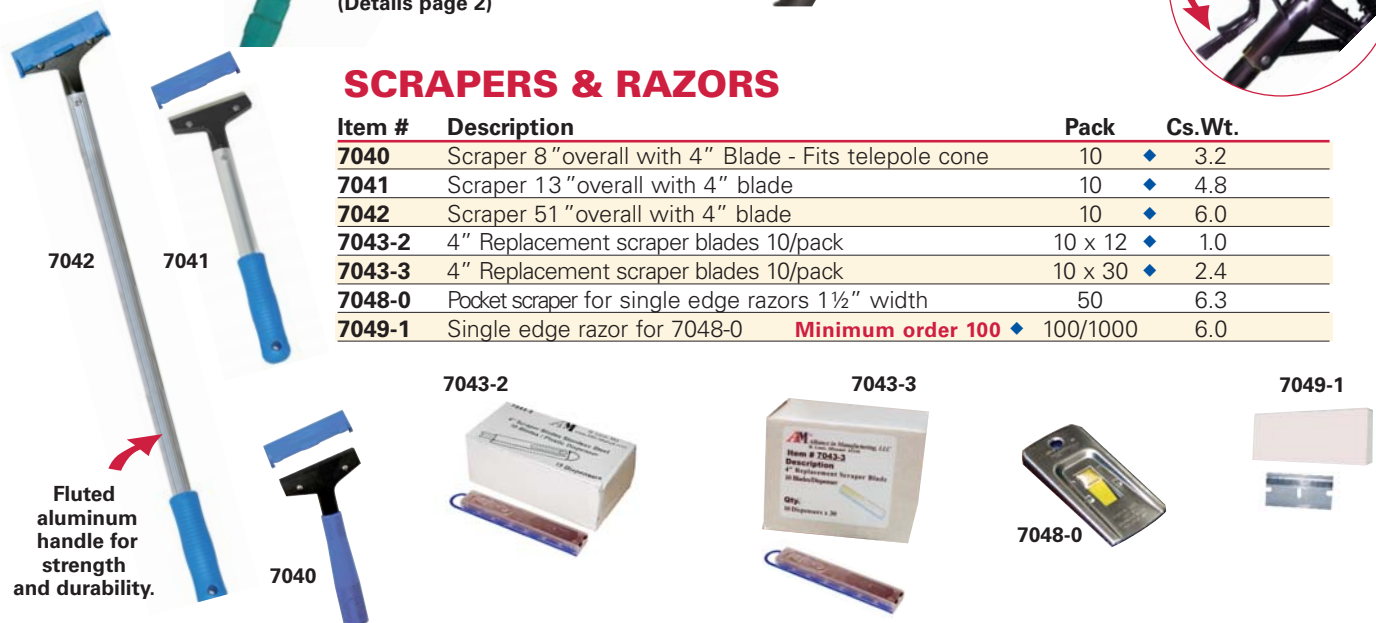

Paper Picker - 40"

Brushed aluminum shaft with ergonomic ABS plastic grip.



Stretchers

This pick-up and clean-up tool is effective in all environments. Rugged construction of stainless, aluminum, rubber and ABS plastic.

- Easily grabs objects as small as a coin and securely holds up to a 5 pound brick.
- Rust-Proof for outdoor use.
- Ergonomic no pinch handle offers comfort & reduces repetitive motion fatigue.

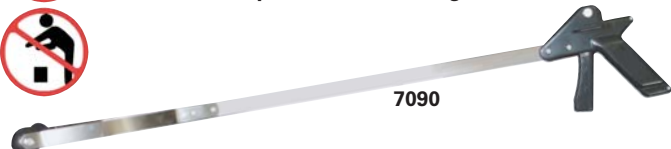

Item #	Description	Length	Pack	Cs.Wt.
7093-0	Picker	40"	10	4.0

Item #	Length	Minimum Order	Cs/Mstr.	Cs.Wt.
7090-2	20"	♦ 6	6/36	3.3/20
7090-3	36"	♦ 6	6/36	4.5/27

MOSS RUBBER FLOOR SQUEEGEES

Standard Duty Steel Frame w/ Moss Rubber Blade

Item #	Description	Minimum Order	Pack Cs / Mstr	Case Wt.
7085-18	Moss Floor Squeegee 18"	◆10	10/40	5.3 /23.1
7085-22	Moss Floor Squeegee 22"	◆10	10/40	6.2 /26.8

Heavy Duty Steel Frame w/ Moss Rubber Blade

7086-22	Moss Floor Squeegee 22"	◆10	10/40	10.2/43.8
7086-30	Moss Floor Squeegee 30"	◆10	10/20	12.6/28.0

Recommended AIM™ Handle 5056 for Moss Squeegees (Page 6)

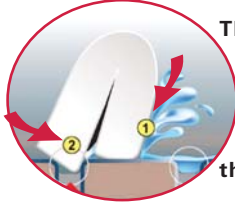

The 1st blade removes the bulk of the liquid.

The 2nd blade follows the surface contour removing all remaining liquid leaving the surface dry to the touch.

- Excellent elasticity.
- High resistance to tearing.
- Closed cells do not absorb liquid.
- Works equally well on smooth or uneven surfaces.
- Rust resistant galvanized metal frame.
- Moss rubber resists UV radiation, which prevents cracking.
- Ideal tool for safer, dryer floors.

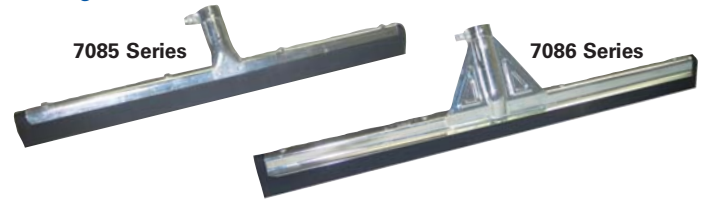

BIG AZZ™ MOSS FLOOR SQUEEGEES

5/8" Moss Rubber Squeegee & 54" Metal Handle Combo

Item #	Description	Pack	Cs.Wt.
7087-24	Floor Squeegee Straight 24"	6 ◆	16.6
7087-36	Floor Squeegee Curved 36"	6 ◆	26.8

- Reinforced electroplated steel support frame.
- Ideal for cleaning grout and tile crevices.
- Faster drying time on smooth surfaces.
- Great for moving large volumes of water.
- Flexible and non-absorbent 98% closed-cell moss rubber blade.
- Shipped KD for economical freight.
- **FREE** 54" vinyl coated steel handle with every squeegee. 58" overall.

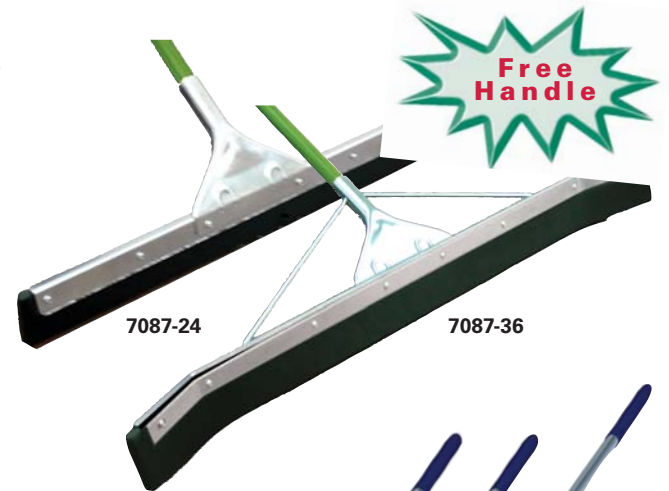

RUBBER FLOOR SQUEEGEES

Heavy Duty Chrome Steel Squeegees & 52" Aluminum Handle

Item #	Description	Pack	Cs.Wt.
1824-S	Floor Squeegee 24" Straight	6 ◆	16.2
1830-C	Floor Squeegee 30" Curved	6 ◆	19.0
1830-S	Floor Squeegee 30" Straight	6 ◆	22.0

- Good for moving liquid and dirt on uneven floors.
- Straight or curved blades.
- 1/4" x 2" black Buna blend rubber blade.
- 3/4" Scraper edge.
- Handle permanently attached to steel handle socket.
- Shipped KD for economical freight.
- **FREE** 1" x 52" aluminum handle with 5" grip. 55" overall.



(See page 3 for Floor Signs)

DUST PANS & BROOMS

Item #	Description	Pack	Cs.Wt.
1320	Dustpan plastic black, 3¼"H x 7"D x 12½"W	24 ♦	13.2
1332	Broom Clip for 1335 & 1336	10 ♦	.3
1333	Lobby Broom filament bristles 37" overall, with 8" sweep. (D-pan clip included)	20 ♦	16.4
1335	Dustpan Lobby 12" black plastic bin, metal handle. 38" overall	20 ♦	36.6
1336	Dustpan Lobby 12" black plastic bin with cover, metal handle, 38" overall.	10 ♦	22.0
1377	Angle Broom 12" sweep 55" overall	12 ♦	19.2



1332 storage Clip



Broom clips to lobby dustpan for convenient storage



Lobby Broom

- Offset handle.
- Unflagged filament bristles.

1333



1320



1335



1336

Lobby Dust Pans

- Plastic and metal construction.
- Handle grip with hanger slot.
- Available with or without cover.

Angle Brooms

- Washable, durable, polypropylene fiber.
- Flagged tips sweep the smallest debris.
- Plastic covered metal handle with hanger.

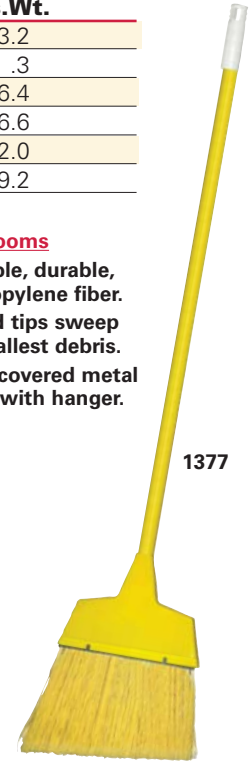

1377

CLEANING ACCESSORIES

Standard Utility Pad Holder



5105 Gray

ACME threaded handle

- 3¾" x 8¾"
- ACME thread
- 360° swivel.
- 2 aggressive Velcro strips.

Deluxe Utility Pad Holder

3½" x 9" Adjustable set screw to control up, down and side movement of handle at pivot-point. This is an important advantage when cleaning baseboards, stairs, walls and ceilings.



Strength by design:

- Double ribs 5" x ¾" along top surface. Minimizes warping and breakage.

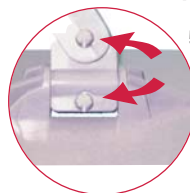

5110

Set screws for swivel adjustment



5110 Gray

ACME or non-threaded handle

Hang Tough™ Sprayers

NEW

- Piston Guard for hanging from carts and barrels
- Janitorial chemicals and general use.
- Adjustable fine mist to forceful stream.
- High output: 1.2 ml per stroke.
- Sediment filter - lengthens sprayer life.
- Longer ergonomic trigger to fit any hand.
- Leak proof and sprays at any angle.
- Self venting to prevent bottle collapse.
- Quart size dip tube is standard.



192-BW

Piston-Guard

AIM's Piston Guard design prevent damage to pump mechanism



Protected

Competitors



Unprotected

This sprayers piston is distorted by bottle and liquid weight when hung on carts or barrels. The sprayers life is dramatically shortened

Recommended AIM™ Handles are 5056 or 5058.

Item #	Description	Pack	Cs.Wt.
5105	Pad Holder	10	3.8
5110	Deluxe Pad Holder	10	5.1

Item #	Color	Pack	Cs.Wt.
192-BW	Blue/White	200 ♦	16.2
192-RW	Red/White	200 ♦	16.2

RESTROOM ACCESSORIES

Item #	Description	Minimum Order Qty.	Pack Scent	Cs. Cs / Mstr	Wt.
1020	Plunger for drain & toilet. with 6" bell, 21" hardwood handle	1 Dz. ♦		12/48	47.0
1025	Bowl Mop w/ wringer 100% acrylic head 12" handle	100 ♦		100	18.0
1030	Bowl Mop 100% acrylic head 12" handle	100 ♦		100	12.2
1055	Urinal Screen w/ non-para block, blue indicator, 1/bag	1 Dz. ♦	Spice	12/72	4.8/29.0
1056	Urinal Screen w/ non-para block 1/bag	1 Dz. ♦	Cherry	12/72	4.8/29.0
1066-1	Urinal Screen (Flat) vinyl Blue	1 Dz. ♦	Citrus	12/48	2.0/12.5
1066-3	Urinal Screen (Flat) vinyl Red	1 Dz. ♦	Cherry	12/72	2.0/12.5
83000	Drain Power, 93% Sulfuric Quarts 	5 Cs. ♦	Characteristic	12	50.0



93% Virgin Sulfuric Acid

- Red color.
- For clogged drain.
-  Hazmat shipping.

83000

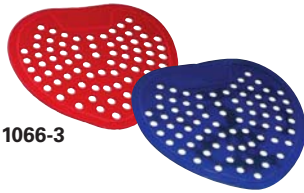

1066-3

1066-1



NEW

1056

1055



1025



1030

The Plumber's Plunger:

- For toilets, sinks or drains.
- Tail piece adapts to application and compresses at all angles.
- Large 6" rubber bell blows through clogs.



1020

Caddy NEW

Hulk Contractor Caddy - Plastic
16" x 10⁵/₈" x 7"

- Tall rounded ergonomic handle.
- Deep compartments prevent bottles and aerosols from spilling.
- Holds 32 oz. bottles



6148

Item #	Description	Pack	Cs.Wt.
6148	Caddy	12 ♦	17.3

Microfiber Cloths

Application

- A All purpose-dusting and cleaning
- B Glass and polishing
- C Rest room.

Item #	Spec.	Size	Usage	Pack	Cs. Wt.
1612-LG-S	Suede	12" x 12"	B	12 ♦	1.0
1616-RD	Textured	16" x 16"	C	10 ♦	1.7

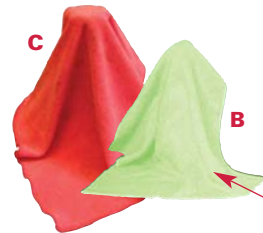

Additional microfiber items on page 4

Suede finish

NAPKIN RECEPTACLES

Item #	Description	Color	L x W x H	Pack	Cs.Wt.
1260	Napkin Receptacle - Plastic, with rigid liner	White	10" x 4 ³ / ₄ " x 12"	6	14.0
1262	Napkin Receptacle - Metal, with metal liner - floor model opens 2 sides	White	9 ¹ / ₄ " x 9" x 11 ¹ / ₂ "	6	44.7



1260

Plastic Receptacle NEW

- Wall or floor mount as single or double.
- Hinged lid helps contain odor.

Easy to remove rigid liner.



1262

Metal Receptacle NEW

- White enamel finish.
- Self closing door.
- Galvanized metal inner liner.
- Floor unit fits between stalls, access on 2 sides.

Galvanized metal liner.



SENSOR SOAP DISPENSERS



Item #	Description	Color	(H x W x D)	Capacity	Case Pack	Case Wt.
1200	Sensor "Liquid & Lotion" Soap Dispenser	Black/White	7½" x 5" x 3¾"	46 oz.	12	15.6
1201	Sensor Foam Soap Dispenser	White	10½" x 4½" x 4½"	34 oz.	12	23.4



1200



1201

Sensor Soap Dispensers

Sensor Bulk Liquid or Lotion Soap Dispenser

- No Box-bulk fill is cost savings plus environmentally responsible.
- Translucent w/ white accent. break-resistant plastic.
- Accommodates liquid or lotion soap.
- Adjustable dispensing rate control (3 cc -10 cc).
- Convex lid cleans easily & discourages cigarette burns.
- Plastic key, lock mechanism.
- Powered with 4 "AA" alkaline batteries. (Batteries not Included)

#1200
Concealed lever controls dispensing rate.



Plastic key, locking mechanism.



Sensor Bulk Foam Soap Dispenser NEW

- No Box-bulk fill is cost savings plus environmentally responsible.
- Economical: Foam soap yields 4x the number of washes vs. liquid soap
- Sustainable: less soap required means lower water usage and waste stream contamination.
- Tear drop sight window for timely refill.
- Plastic key, lock mechanism.
- Powered with 3 "C" alkaline batteries. (Batteries not Included)

1 liter capacity allows less servicing than standard 800 ml refills



1201

LED lights when batteries are low.



JUMBO TOILET TISSUE DISPENSERS



Item #	Description	(H x W x D)	Capacity	Core Dia.	Case Pack	Case Wt.
1280	9" JTT Roll Dispenser	11¾" x 11" x 5¼"	(1) 9" Dia. Roll	2¼" - 3⅜"	6 ♦	17.6
1285	9" JTT Dual Roll Dispenser	20½" x 11½" x 5"	(2) 9" Dia. Rolls	2¼" - 3⅜"	3 ♦	16.5
1290	13" JTT Jumbo Jumbo Roll Dispenser	15¼" x 15¼" x 5¼"	(1) 13" Dia. Roll	2¼" - 3⅜"	3 ♦	13.0

NEW

JTT Single 13" Roll Tissue Dispenser accommodates up to 13" rolls.

JTT Single 9" Roll Tissue Dispenser



1280

- Translucent (dark smoke) break-resistant plastic.
- Dispenses perforated or non-perforated tissue, 1 or 2 ply.
- Versatile 2¼" - 3⅜" core.
- Easy loading reduces labor cost.
- Metal keyed lock.



1290

JTT Dual 9" Roll Tissue Dispenser



1285

- Totally eliminates stub-roll waste.
- Reduces labor cost.
- Versatile.
- Prevents pilferage.
- Durability.

- Holds two rolls up to 9" diameter. The equivalent of 11½ rolls of standard 2-ply tissue.
- Sliding gate restricts access to second roll before roll in use is consumed.

TOWEL DISPENSERS

Item #	Description	(W x D x H)	Capacity	Core Dia.	Case Pack	Case Wt.
1229	Combo C-Fold or Multi-Fold Dispenser heavy gauge steel - White Enamel	11¼" x 4½" x 15¼"	335 C-Fold 540 Multi-Fold		6 ♦	38.0
1230	Combo C-Fold or Multi-Fold Dispenser break resistant plastic	11½" x 5" x 14¼"	300 C-Fold 500 Multi-Fold		10 ♦	37.6
1240	Center-Pull Dispenser	9¼" x 9" x 11"	9" W x 8" Dia.		6 ♦	21.0
1245	Lever Roll Dispenser	11" x 10" x 12¾"	8" W x 8" Dia.	1½"-2"	3 ♦	17.0
1251	Sensor Roll Dispenser w/ stub-roll capacity	10¼" x 9" x 15¼"	8" W x 8" Dia.	1½"-2"	1	6.0
1254	Mechanical Roll Dispenser w/ stub roll capacity	10½" x 8¾" x 15¾"	8" W x 8" Dia.	1½"	1	9.0



1229

#1229 Metal Combo C-Fold or Multi-Fold Dispenser

- Heavy gauge steel construction with white enamel finish.
- Unique variable towel slot panel eliminates wasted towels.
- Double-latch metal lock with industry standard key.
- Capacity 335 C-Fold, 540 M-Fold.



1230

#1230 Combo C-Fold or Multi-Fold Towel Dispenser

- Translucent smoke black resilient plastic.
- Unique variable towel slot panel eliminates wasted towels.
- Double-latch metal lock with key.
- Capacity 300 C-Fold, 500 M-Fold.

#1240 Center-Pull Dispenser

- Translucent smoke black break-resistant plastic.
- Dispenses 8" diameter roll in a variety of perforated paper grades.
- Side entry for one hand loading.
- Whisper-quiet dispensing.
- Double-latch metal lock with key.
- Mounting plate detaches for easy installation.



1240

#1245 Lever Roll Dispenser

- Translucent smoke black break-resistant plastic.
- Accommodates most 8" wide rolls and up to 8½" diameter rolls. (Up to 850 Feet)
- Core diameter 1½"
- Dispenses towels in 5" increments.
- Double-latch metal lock with key.



1245

#1254 Auto Cut - Mechanical Roll Dispenser NEW

with stub-roll capacity

- Translucent smoke black.
- Universal for most brands of 8" x 8" dia. non-perforated roll towels with *adequate wet strength*.
- Auto cut dispenses 11½" sheet.
- Low pull force, smooth and quiet
- Double-latch lock with industry standard key.
- Metal back.
- High capacity - hold longest roll.
- Transfer system with 2¾" diameter stub roll capacity prevents waste.
- Touchless: No levers, cranks or buttons-eliminates cross contamination.



1254



#1251 Sensor Roll Dispenser NEW

with stub-roll capacity

- Translucent smoke color break-resistant plastic.
- Dispenses non-perforated roll towels up to 8" diameter and 8" wide.
- Transfer system with 2¾" diameter stub roll capacity.
- 3 paper length 9", 12" or 15".
- Second sheet saver setting.
- Time delay settings for 1, 2, or 3 seconds.
- Mounts directly through plastic back for convenience and security.
- Plastic lock with metal key.
- Requires - 4 "D" cell alkaline batteries or AC plug-in adapter. (Not Included)



1251

HULK ROUND RECEPTACLES & LIDS

Item #	Description	Color	Pack	Cs.Wt.
20	Receptacle 20 gal.	Gray	6	35.0
21	Lid 20 gal. Flat	Gray	6 ♦	9.0
30	Caddy Bag Fits 32, 44, & 55 gal.	Yellow	2	2.5
32	Receptacle 32 gal.	Gray	6	46.0
33	Lid 32 gal. Flat	Gray	6 ♦	13.0
36	Funnel Top Lid 32 gal.	Gray	4	14.0
44	Receptacle 44 gal.	Gray	4	54.0
45	Lid 44 gal. Flat	Gray	4 ♦	11.6
55	Receptacle 55 gal.	Gray	3	52.4
56	Lid 55 gal. Flat	Gray	3 ♦	12.8
60	Dolly-5 non-marking 3" casters	Charcoal	2 ♦	16.5
254	Recycle Label 4" x 5" Weather-Proof	Clear Mylar White Copy	24 ♦	1.2

- Double ribbed base for strength and drag resistance.
- Reinforcing radial ribs under rim and base.
- Molded in handles for safe lifting and nesting.
- Tough snap-on lids secure contents.
- Other colors available.



Replaceable heavy duty 3" casters with 7/16" diameter threaded stem exceeds normal performance requirements.

Dolly twists on and off without tools. Fits 20, 32 44 & 55 gallon receptacles.



Caddy fits 32, 44 & 55 gallon receptacles.



AIM's 13 pocket caddy design offers additional capacity.



FUNNEL TOP LID FEATURES: NEW

- Built-in handles allow for easy removal.
- Snaps securely on the 32-gal. AIM Hulk receptacles.
- Fits all major competitors.
- Ideal for indoor applications fast food, catering, stadiums, retail, educational and hospitality environments.

Large 10" opening for high volume applications.



Tab at each handle securely lock the Funnel Top to the receptacle.

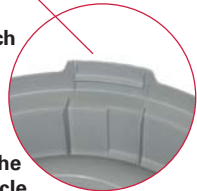

SPACE-MISER RECEPTACLES & FREE DROP LIDS

Item #	Description	L x W x H	Color	Pack	Cs.Wt.
23	Miser 23 gal. Receptacle	11" x 23" x 30"	Beige, Brown & Gray	4	26.0
24	Miser Lid	11 3/8" x 20 1/2" x 4 1/2"	Beige, Brown & Gray	4 ♦	10.0



Reinforced handles for moving or lifting.

Gravity lid opens hands-free

Built-in poly bag cinch

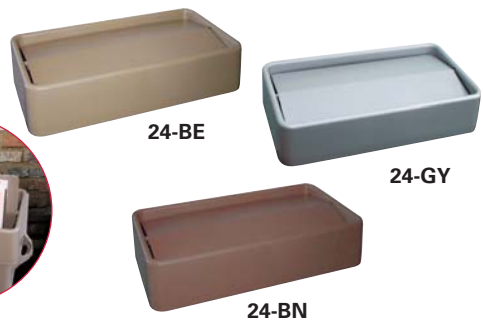

- High capacity container designed for tight places.
- Free Drop lid provides easy access while covering unsightly trash.
- Handles provide easier lift and carry convenience.

SLIM RECEPTACLES & TOPS NEW

Item #	Description	Capacity	L x W x H	Color	Pack	Cs.Wt.
16	Receptacle without top	16 gal.	17¾" x 13" x 23"	Gray	4 ♦	11.3
16-H	Receptacle with Bottle & Can Top	16 gal.	17¾" x 13" x 31"	Gray/ Yellow	4 ♦	28.0
16-P	Receptacle with Push Door Top	16 gal.	17¾" x 13" x 31"	Gray/ Dk.Gray	4 ♦	30.8
16-S	Receptacle with Paper Recycling Top	16 gal.	17¾" x 13" x 31"	Gray/ Dk. Gray	4 ♦	27.8
17-H	Top Only Bottle & Can for #16 & #16-H		17¾" x 13" x 9"	Gray/ Yellow	4 ♦	19.2
17-P	Top Only Push Door for #16 & #16-P		17¾" x 13" x 9"	Gray/ Dk. Gray	4 ♦	21.5
17-S	Top Only Paper Recycling for #16 & #16-S		17¾" x 13" x 9"	Gray/ Dk. Gray	4 ♦	18.5
254	Recycling Label 4" x 5" Weather-Proof Mylar		4" x 5"	Clear/White	24 ♦	1.2

- Serves as convenient central collection site for many work stations, near copiers, break rooms, in schools, offices or plant.
- Receptacle has rolled rim and two large handles for safe lifting.
- High-capacity solution for efficient sorting of recyclables.
- Restricted-entry lids, provide visual cues to encourage compliance.
- Additional recycling Labels are available.

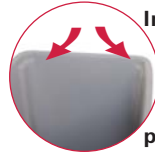

Internal vent ribs break the vacuum when removing poly liner.



16-S Slot "Paper"

16-H Bottles & Cans

16-P General Purpose

Mylar Recycling Labels are available to further identify function



254

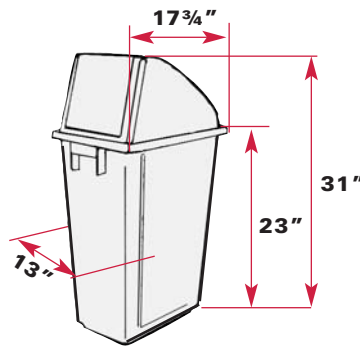

17-P Top has a counter weighted door for consistent closure.

UL CLASSIFIED WASTEBASKET

Item #	Description	L x W x H	Pack	Cs.Wt.
8UL	Wastebasket 8 quart	9" x 6½" x 10⅞"	6 ♦	13.5
14UL	Wastebasket 14 quart	11¼" x 8" x 12½"	6 ♦	24.5
28UL	Wastebasket 28 quart	16½" x 9½" x 14"	6 ♦	40.5

Black

Brown

Lt. Gray

Sand

- Combines safety and appearance.
- Round corners for safety.
- Smooth finish inside and out - no texture to hold dirt and germs.
- Rugged fiberglass plastic resists breakage.

Underwriters Laboratories Classification

Contains burning paper without the wastebasket melting or contributing fuel to the container's contents.



14UL-BK

8UL-SD

WHEELIE RECEPTACLE NEW

Item #	Description	L x W x H	Color	Pack	Cs.Wt.
65-GY	Receptacle with hinged lid 65 gallon capacity	19" x 31" x 42"	Gray	4	62.0

- Applications for refuse contract cleaning and recycling.
- Heavy-duty, 8" non-marking wheels.
- Rounded corners and smooth contours are easy to clean.
- Inset wheels prevent damage to walls and doorways.
- Attached hinged lid fits tightly; swings back out-of-the-way.
- Reinforced Push/Pull handles.
- Base grip for easy dumping.
- Steel axle for years of service.

Hatch-Back Lid provides second entry for small debris without opening main lid.



65-GY

WINDOW SQUEEGEES

Stainless Steel Squeegee

Squeegee handle has ribbed rubber grip and quick-change spring release. The channel and jaw-clamp positively grip the rubber blade, preventing twisting and wobbling.



7000-0

Item #	Pack	Cs.Wt.
7000-0	Handle only 12 ♦	3.9

Stainless Steel Squeegee (Complete)

Item #	In.	Pack	Cs.Wt.
7100-06	6	12 ♦	5.3
7100-10	10	12 ♦	5.9
7100-12	12	12 ♦	6.3
7100-14	14	12 ♦	6.7
7100-16	16	12 ♦	6.9
7100-18	18	12 ♦	7.5
7100-22	22	12 ♦	7.9



7100-XX

Plastic/Aluminum Squeegees

Professional, but light weight tool. Sharp edge rubber blade and aluminum channel are secured by a convenient wing nut. Easily mounts to telescopic poles.



7150-XX

Item #	In.	Pack.	Cs.Wt.
7150-10	10	12 ♦	4.0
7150-14	14	12 ♦	4.1
7150-16	16	12 ♦	4.2

Channel Stainless Steel with Soft Rubber Blades

Item #	In.	Pack	Cs.Wt.
7000-06	6	12 ♦	1.4
7000-10	10	12 ♦	2.0
7000-12	12	12 ♦	2.4
7000-14	14	12 ♦	2.8
7000-16	16	12 ♦	3.0
7000-18	18	12 ♦	3.6
7000-22	22	12 ♦	3.8



7000-XX

"Soft" Rubber Blade Replacements

- Vulcanized for elasticity, strength and stability.
- Laser-True edge.
- Consistent quality for optimum performance.
- 100% Guaranteed.

Item #	In.	Pack	Cs.Wt.
7012-06	6	12 ♦	.4
7012-10	10	12 ♦	.7
7012-12	12	12 ♦	.8
7012-14	14	12 ♦	.9
7012-16	16	12 ♦	1.0
7012-18	18	12 ♦	1.1
7012-22	22	12 ♦	1.2
7012-36	36	12 ♦	2.0



7012-XX

TELESCOPIC POLES

- 4 point internal lock ring and solid exterior collar insures slip-free use.
- Light weight, manufactured from structural extruded aluminum tubing.
- Durable easy lock coupling secure poles at selected lengths.
- Many tools snap-fit onto pole, press fit or screw onto cone.
- Cone included with each telepole.



7052 Series

7053 Series

Telescopic Poles 2 Sections Aluminum

Listed size is extended length.

Item #	Ft.	Pack	Code	Cs.Wt.
7052-08	8	4	A	4.3
7052-13	13	4	B	7.5

3 Sections Aluminum

7053-10	10	4	A	8.5
7053-14	14	4	A	10.5
7053-20	20	4	B	11.2
7053-30	30	4	C	15.0

♣ Ship by Truck Only

♦ Telescopic Pole Minimum Order:
Any 4 poles per Letter Code

TELESCOPIC POLE ACCESSORIES

Item #	Description	Pack	Cs.Wt.
7050-0	Cone 4 3/4"	5	.5
7052-2	Crank Joint	5	1.2
7050-5	Wall Brush 6" x 13"	10	5.0
7050-6	Pipe Brush 6" x 11"	10	5.0

Cone



Cone included with each telepole

Crank Joint



Crank Joint Angle Adapter

Wall Brush 100% Horse Hair Bristles

13" x 6" Oval brush for cleaning walls, ceilings and removing cobwebs from ceilings, fans.



7050-5



7050-6

Pipe Brush 100% Horse Hair Bristles

11" x 6" Curved pipe brush for cleaning pipes and fixtures. Flexible.

T-BARS & SLEEVES

AIM's Washer Sleeves are designed for the correct water retention and nap to clean windows with minimal effort.

- Machine washable.
- Reinforced ends and inside loop.

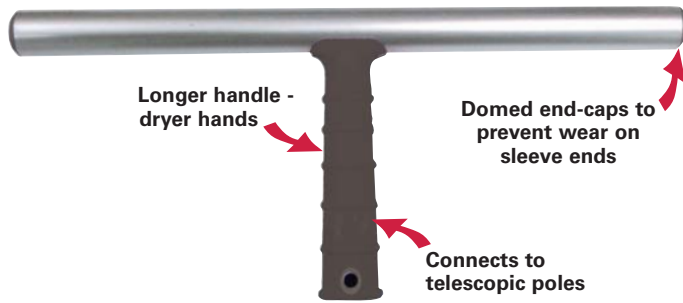

T-Bar Handles Aluminum

Aluminum and plastic with domed end to prevent wear on sleeve.

Item #	Length	Pack	Cs.Wt.
7020-10	10	10	2.5
7020-14	14	10	2.8
7020-18	18	10	3.0
7020-22	22	10	4.0

T-Bar Handles Plastic

Solid one piece structural plastic. Honey combed for water retention.

Item #	Length	Pack	Cs.Wt.
7025-10	10	10	2.6
7025-14	14	10	3.0
7025-18	18	10	3.4
7025-22	22	10	3.8

T-Bar Handles Adjustable

180° Swivel adjustment to meet a variety of cleaning requirements. Aluminum and plastic. Accommodates telescopic pole.

Item #	Length	Pack	Cs.Wt.
7024-14	14	10	3.4
7024-18	18	10	4.0



Sleeve " Microfiber "

100% Polyester nap, height 5/8". The coarse yarn acts as an abrasive, while the finer yarn degreases and absorbs. This combination of fibers provides a fabric with exceptional high cleaning power.

Item #	Length	Pack	Cs.Wt.
7032-10	10	10	1.8
7032-14	14	10	2.1
7032-18	18	10	2.5
7032-22	22	10	2.9



Sleeve " White "

White woven poly-acrylic, machine washable. Nap designed for water retention & durability.

Item #	Length	Pack	Cs.Wt.
7030-10	10	10	1.1
7030-14	14	10	1.4
7030-18	18	10	1.8
7030-22	22	10	2.2

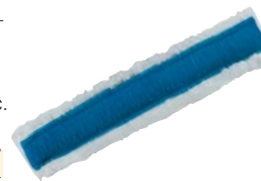

Sleeve " Blue Scrub Strip "

White woven poly-acrylic on one side and a non-abrasive strip sewn on the other side.

Item #	Length	Pack	Cs.Wt.
7038-10	10	10	1.8
7038-14	14	10	2.0
7038-18	18	10	2.1
7038-22	22	10	2.4

WINDOW CLEANING ACCESSORIES



The Win•Tote contains the following items:

- Squeegee handle stainless steel
- 1.5" Pocket scraper
- 6", 12" & 18" Channel with rubber
- 36" Replacement rubber
- 14" T-Bar with white sleeve
- Clamp jaw plastic
- Microfiber cloth
- 8' Telescopic pole 2 section

Item #	Description	Pack.	Cs.Wt.
7065-WT	Win-Tote Kit	1	11.2



Rectangular Bucket - 6 gal

- Heavy-duty, polyethylene bucket. 19 1/4" x 9 1/2" x 9 1/2"
 - 1 set of single & double squeegee hangers **FREE** with each bucket.
 - Accommodates up to an 18" washer sleeve.
- (Swivel casters available)

7070-0

Item #	Description	Pack	Cs.Wt.
7070-0	Bucket 6 gal. Capacity (19 1/4" x 9 1/2" x 9 1/2")	10	30.8
7070-1	Casters Set	1 Set of 4	.7

Application

- A All purpose-dusting and cleaning.
- B Glass and polishing.

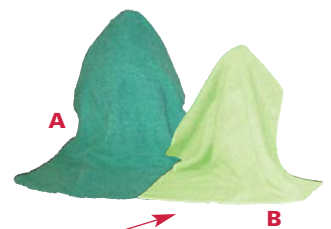

Suede finish

Additional microfiber items on pages 4 & 9



Water Holster with Belt Clip - Dripless

Belt clip attaches without belt removal. Holds long washer, squeegees, extra channels, scraper and one pint of liquid. Reversible right or left side.

Belt 2" Heavy Duty Nylon

Slide release buckle for years of service. Adjustable up to waist size 44".



Item #	Description	Pack	Cs.Wt.
7061-0	Holster with Belt Clip	5	3.8
7061-2	Belt	5	2.0

Item #	Size	Spec.	Usage	Pack	Cs. Wt.
1612-LG-S	12" x 12"	Suede	B	12	1.0
1616-GN	16" x 16"	Textured	A	10	1.7

JANITOR CART

Item #	Description	Color	L x W x H	Pack	Cs.Wt.
6150	Janitors Cart with 25 gallon Vinyl Bag	Gray	44 $\frac{3}{8}$ " x 20" x 37 $\frac{3}{4}$ "	1	44.0
6154	Bag Vinyl 25 gallon	Yellow	11 $\frac{3}{4}$ " x 15" x 27"	1	1.3
6155	Bag Vinyl Zipper 25 gallon	Yellow	11 $\frac{3}{4}$ " x 15" x 27"	1	1.3

- Easy to clean Structo Plastic.
- Adjustable center shelf.
- Handle folds for convenient storage.
- Standard bag included, zipper bag optional.
- Molded-in hooks for tools and mop handles.
- Accommodates most buckets and barrels.
- Non-Marking 8" rear wheels & 3" swivel casters.



2 position center shelf adjusts to meet storage requirements.



Smart Solution !



See Page 3 for details on Pop-Sign

Pop-Sign Holster easily attaches to cleaning carts. Immediate on-the-spot warning and compact storage.



Handle folds for convenient storage.

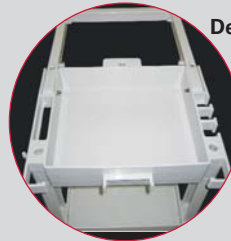

Design provides for a variety of mop handles & tools.



Non-Marking 8" rear wheels.

etcetera UTILITY CARTS

Item #	Description	Color	L x W x H	Casters	Capacity	Pack	Cs.Wt.
6205	ETCetera Utility Cart Standard	Lt. Gray	33 $\frac{1}{2}$ " x 17" x 37 $\frac{1}{2}$ "	3"	200	1	24.0
6210	ETCetera Utility Cart Large	Lt. Gray	40 $\frac{1}{2}$ " x 20" x 37 $\frac{1}{2}$ "	4"	300	1	36.0



300 pound cart capacity

6210

Too many uses to name!

- Applications in commercial, institutional, industrial and etc. etc. etc.
- Handles on both ends for easy maneuverability.
- Non-marking swivel casters.
- Sturdy, smooth structolene shelves with brushed aluminum uprights.
- Designed to accept refuse & utility bins.
- All shelves have $\frac{3}{4}$ " high load stabilizer edges on three sides.



200 pound cart capacity

6205

4 Non-marking swivel casters.



Brushed aluminum uprights.



Shelves have $\frac{3}{4}$ " high load stabilizer edge & $\frac{1}{4}$ " high entry edge.

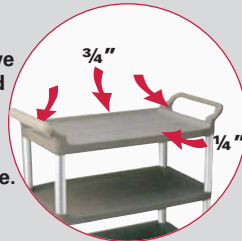

Textured shelves offer a non-slip surface, yet easy cleanability.



AIM™ Alliance in Manufacturing, LLC

3736 Windsor Place, St. Louis, Missouri 63113 U.S.A.

TEL: 314-333-4323 or 800-613-1086
FAX: 314-333-4326 or 800-613-1096

E-Mail: Customer-Service@AIM-Alliance.com
Website: www.AIM-Alliance.com

